

+

2019 5

+

1.	<b>AWS</b>	.....	<b>3</b>
2.	<b>VMWare</b>	.....	<b>4</b>
3.	<b>GOOGLE</b>	.....	<b>5</b>
4.	<b>Azure</b>	.....	<b>5</b>
5.		.....	<b>6</b>
6.		.....	<b>7</b>
7.		.....	<b>8</b>
1.	<b>Openstack</b>	.....	<b>10</b>
2.	<b>Easystack</b>	.....	<b>11</b>

3.	<b>99CLOUD</b>	.....	<b>12</b>
1.		.....	<b>13</b>
2.		.....	<b>16</b>
3.		.....	<b>18</b>
4.		.....	<b>20</b>
5.		.....	<b>21</b>
6.		.....	<b>21</b>
7.		.....	<b>22</b>
8.		.....	<b>23</b>
1.	<b>Helm 3.0 alpha</b>	.....	<b>25</b>
2.	<b>Docker 3.0</b>	.....	<b>26</b>
3.	<b>kubeCDN Kubernetes CDN</b>	.....	<b>27</b>
1.	<b>“ 2.0” 12 1</b>	.....	<b>28</b>
2.	<b>Windows “WannaCry”</b>	.....	<b>29</b>
3.	<b>2011</b>	.....	<b>29</b>
4.	<b>Windows 10 Oday</b>	.....	<b>30</b>
5.	<b>Android iOS</b>	.....	<b>30</b>
1.		.....	<b>31</b>
2.		.....	<b>31</b>



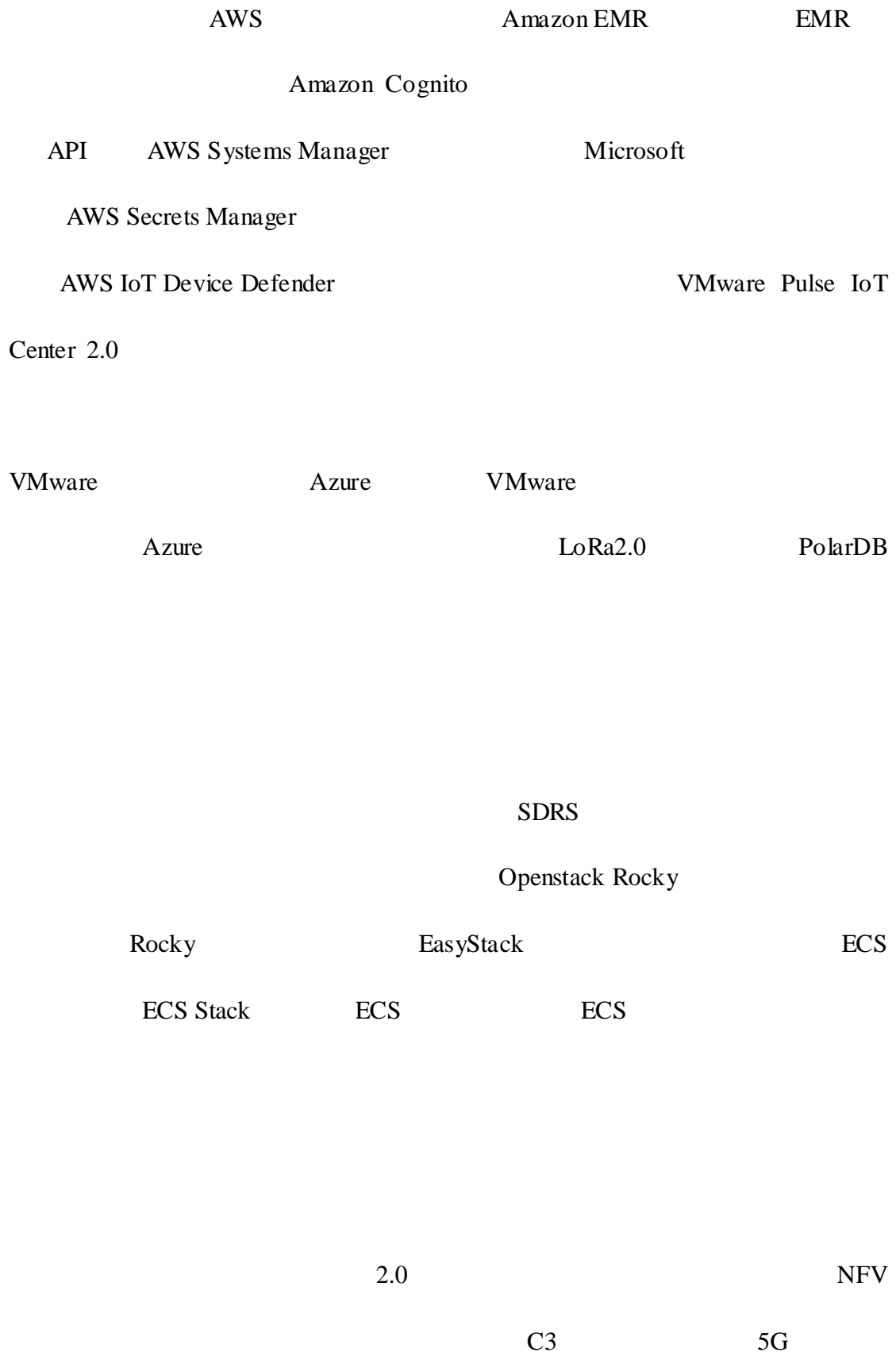

VirusTotal

AiLPHA

2019

Helm 3.0 alpha

kubernetes

Docker

Docker Enterprise 3.0

KubeCDN

Kubernetes

CDN

2.0

12 1

Windows

WannaCry

Windows 10

0day

2011

Android

iOS

2

3

Elevate Security

Phish5

Phish5

KnowBe4

CLTRe

CLTRe

HyperQube

50

SOAR

Siemplify

3000

C

GuardiCore

6000

C

2019 5 30

+

# 1. AWS

## 1.1 Amazon EMR

## EMR

5 1 Amazon EMR EMR  
 EMR Apache Hadoop Apache  
 Spark Apache Hive Hue EMR  
 Amazon EMR  
 CLI

## 1.2 Amazon Cognito

## API

5 6 Amazon Cognito Cognito API  
 AdminSetUserPassword API  
 Amazon Cognito Web  
 Amazon Cognito SAML 2.0  
 Facebook Google Amazon

## 1.3 AWS Systems Manager

## Microsoft

5 7 AWS Systems Manager Amazon EC2  
 Microsoft Microsoft  
 Microsoft Windows AWS Systems Manager  
 Microsoft  
 Systems Manager  
 AWS  
 Microsoft  
 EC2 Microsoft

CLI API

### 1.4 AWS Secrets Manager

5 8 Python .NET Go Secrets Manager

AWS Secrets Manager

API

2018 Secrets Manager Java JDBC

Secrets Manager

API

Secrets Manager

### 1.5 AWS IoT Device Defender

5 15 AWS IoT Device Defender

AWS IoT Core

AWS IoT Device Defender

IoT

AWS IoT Device Defender

AWS IoT Core

AWS IoT

Device Defender

AWS IoT

Device Defender

IP

/

/

TCP/UDP

IP

## 2. VMWare

### 2.1 VMware Pulse IoT Center 2.0

5 7 VMware

VMware Pulse IoT Center

VMware Pulse IoT Center 2.0

/

Pulse IoT

Center 2.0

IT OT

VMware Pulse IoT Center 2.0

### 3. GOOGLE

3.1

5 13

TrueVUE

TrueVUE SaaS

API-first

TrueVUE

### 4. Azure

4.1 VMware

Azure

VMware

5 1

VMware

Azure

VMware

Azure

Azure

VMware

Windows

5.

5.1 **LoRa2.0**

5 20 LoRa2.0

LoRa LoRa IP  
LoRa LoRa1.0 2.0  
1.0 2.0

5.2 **PolarDB**

5 21 PolarDB  
MySQL PostgreSQL Oracle  
1/6 40

PolarDB 2018

5.3

5 23

5.4

5 26

2014

6.

6.1

5 17

6.2

5 20

AI

AI

OTT

TV

TV

AI

6.3

5 24

,

,

,

,

APP

,

,

,

,

,

,

,

1400

,

;

,

,

,

7.

7.1 **SDRS**

5 9 Storage Disaster Recovery Service SDRS  
SDRS

RPO=0

SDRS

**SDRS**

1

SDRS RPO=0

RTO 30min

SDRS

2

SDRS

TCO 60%

MAC

SDRS

License

3

SDRS

SDRS

7.2

**FusionPlant**

5 27

2019

+

FusionPlant

5G

ICT

FusionPlant

2C

2B

2B

OT ICT

OT ICT

2019

+

440

4.3

FusionPlant

AI

1

App

APP

50% 100% 90% 20%

IEEE IEC

2019

AI

ModelArts

ModelArts

AI

- -

AI

AI

FusionPlant

ICT

# 1. Openstack

2000 / IO CPU/ LBaaS/RabbitMQ/Mariadb  
InCloud OpenStack Rocky  
HA HA  
HA InCloud OpenStack Rocky  
/ 500+  
InCloud OpenStack Rocky  
I/O  
InCloud OpenStack Rocky

## 2. Easystack

### 2.1 EasyStack

2019 5 24 ECS  
EasyStack ECS  
EasyStack 18  
ECS Stack ECS ECS  
500+ ECS

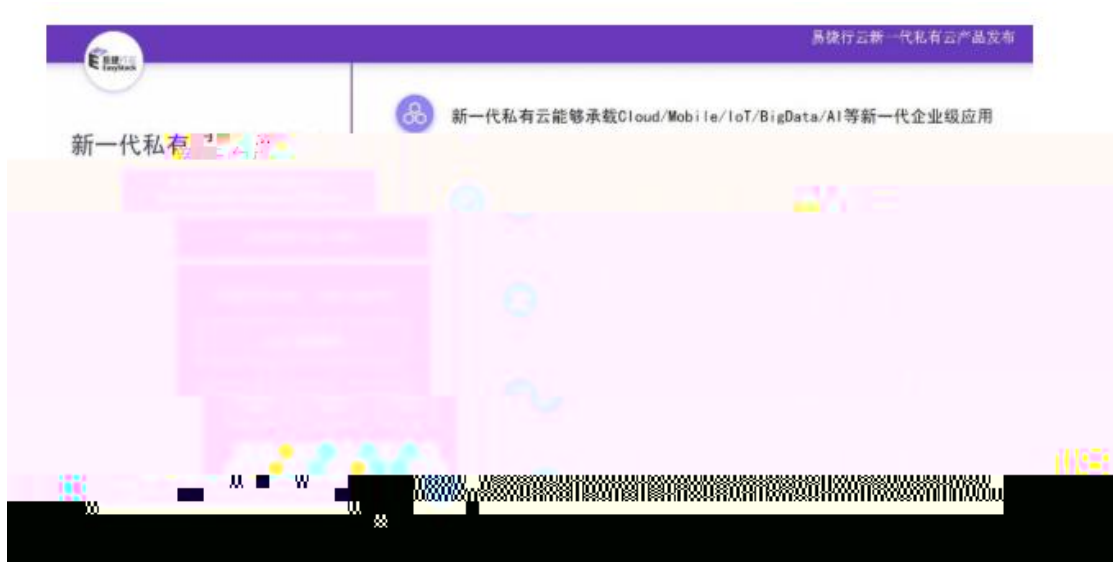

EasyStack

ECS

IaaS SaaS

### 3. 99CLOUD

3.1 2018-2019 MEC

5 16 -17

5.17

2019 MEC

200

5G

5G+MEC

ETSI

2018-2019

MEC

5GMEC

5G

CORD,Starlingx,Akraino, OpenStack Edge Group

MEC

ETSI MEC

# 1.

## 1.1

2019

10000+

20%

91

100

SaaS



SaaS

2019

SaaS

2017

2017 4 27

429

SaaS

IT

SaaS

IT

U

## 1.2

2019

2020

70%

IPv6

HTML WORD Excel PDF

CCID

2018

2017

23.2%

IT

1.3

- 
- 
- 

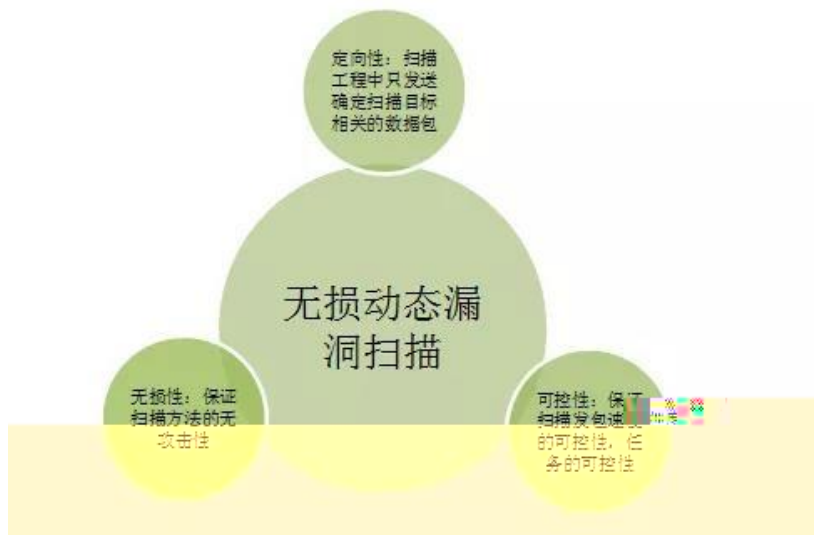



### 可视化的工控系统安全风险展示

工控系统专用版能够可视化的展示工控系统的端口服务、漏洞风险分布情况、账号分布及过去一段时间的变化趋势。



### 全面的工控系统漏洞扫描能力

漏洞库覆盖工程师站、操作员站、OPC、PLC、DCS、数字化设计制造软件平台。



### 准确的工控系统信息发现能力

采用先进的指纹、端口服务识别技术，精确识别工控系统、端口、服务信息。

## 2.

2.1

2.0

5 16

2.0

1200

8000

2.0

2.0

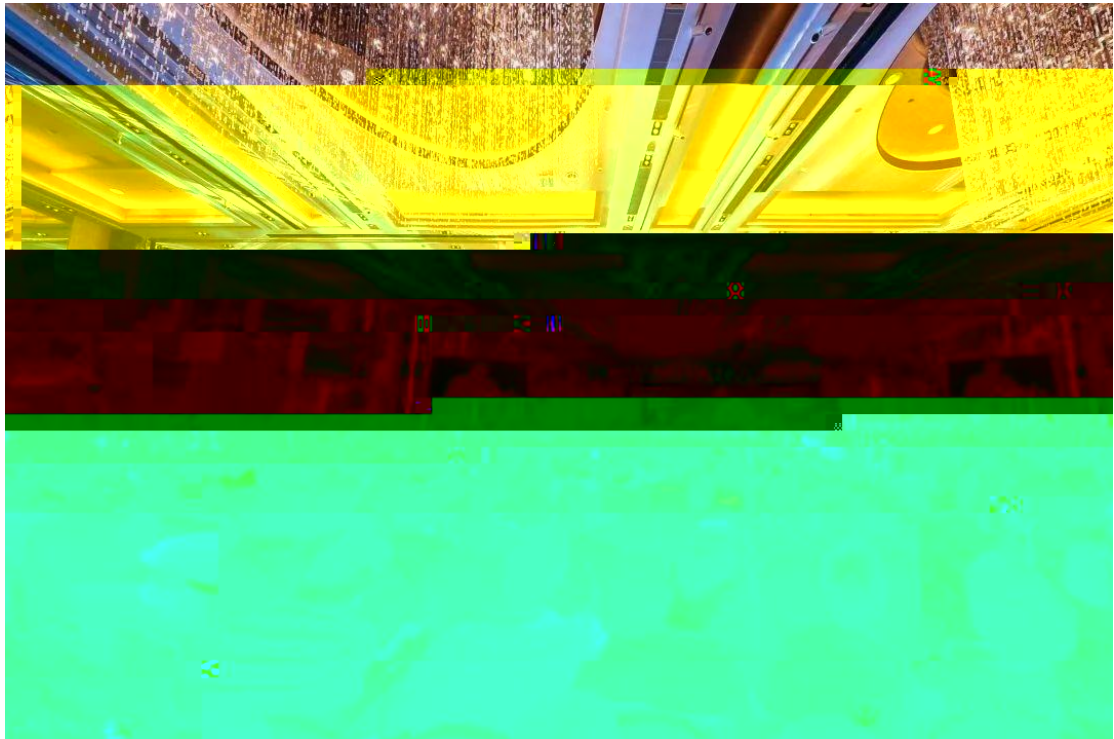

2.0

**CEO**

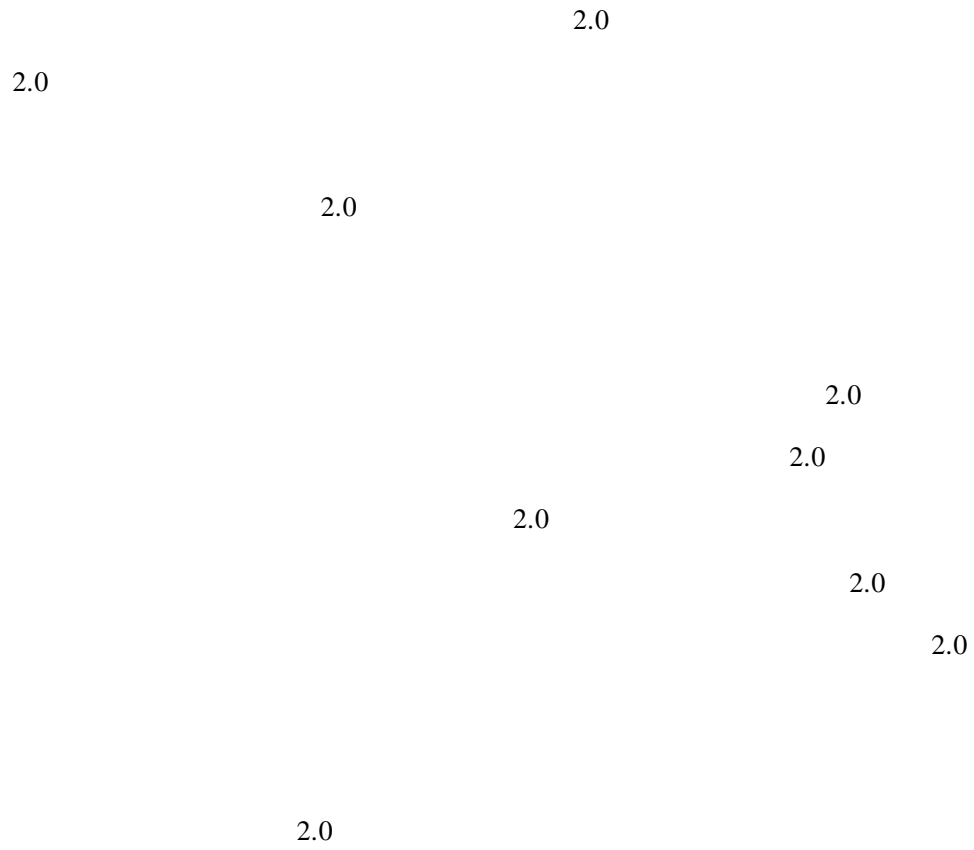

**3.**

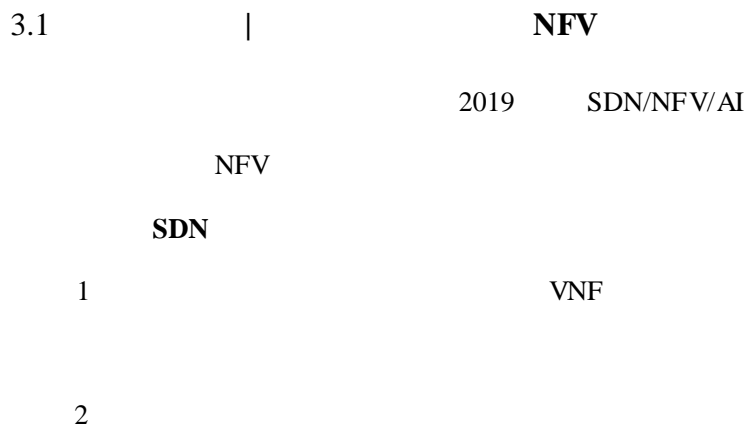

|

**NFV**

2019 SDN/NFV/AI

NFV

**SDN**

VNF

3

/SDN

NFV

SDN

NFV

SDN

VNF PNF

/

NFV

PNF/VNF

VPC

VNF

vFW

PNF

vSYS

# 面向NFV的安全网元管理方案-山石云·集

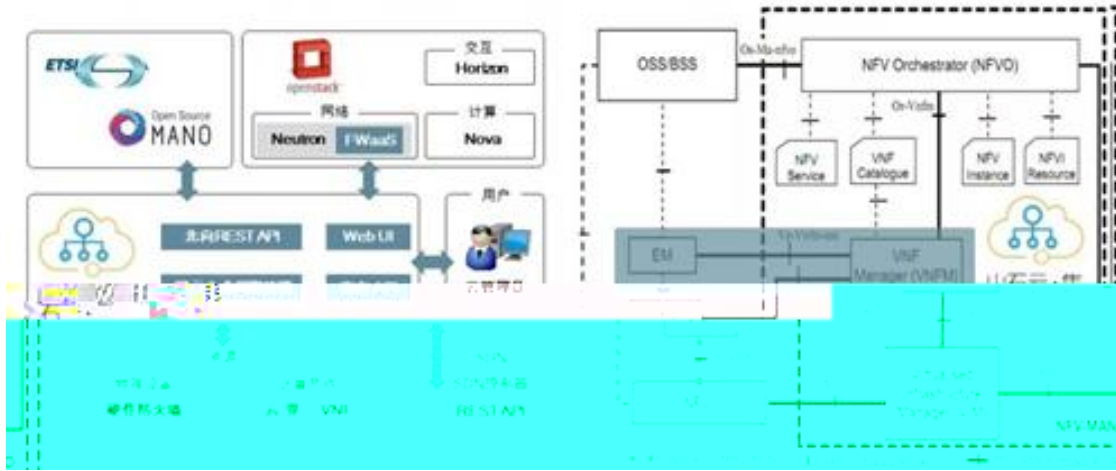

## 4.

4.1

C3

5G

2019

C3

5 7 -8

C3

Cyber

Cloud

Communication

Plan UP

2500 IT

5G

5G

5G

5G

5G

5G

IT OT Operation Technology

CT Communication Technology

ST Security Technology

5G

5G

5G

5G

5G

5G

5G

5G

5G

5G

5G

## 5.

5.1 **VirusTotal**

5 7 VirusTotal

POMA

VirusTotal

VirusTotal

VirusTotal

POMA

POMA

EXE PDF Office JAVA Flash

STIX

## 6.

6.1 **2019 AiLPHA**

5 26 2019

AiLPHA

2019

AiLPHA

2019



AiLPHA

AiLPHA

- 
- 
- 
- 
- 
- 
- 

7.

7.1

5 29 2019

5G



Office

USB

SCADA ATM

CPU

CPU

# 1. Helm 3.0 alpha

Helm 3 alpha ,

**Tiller**

Helm 2 C/S helm Tiller Tiller Kubernetes

; Helm3 Release

helm tiller Helm3 Helm

Helm3 Tiller , Kubernetes

Helm3 tiller

Helm Kubeconfig

chart

**CLI**

helm inspect -> helm show

helm fetch -> helm pull

helm delete --purge -> helm uninstall

helm delete -> helm uninstall --keep-history

requirements.yaml      Chart.yaml

helm3      --generate-name

chart      helm serve

chart      docker registry

**2. Docker      3.0**

Docker      DockerCon 2019

Docker Enterprise 3.0

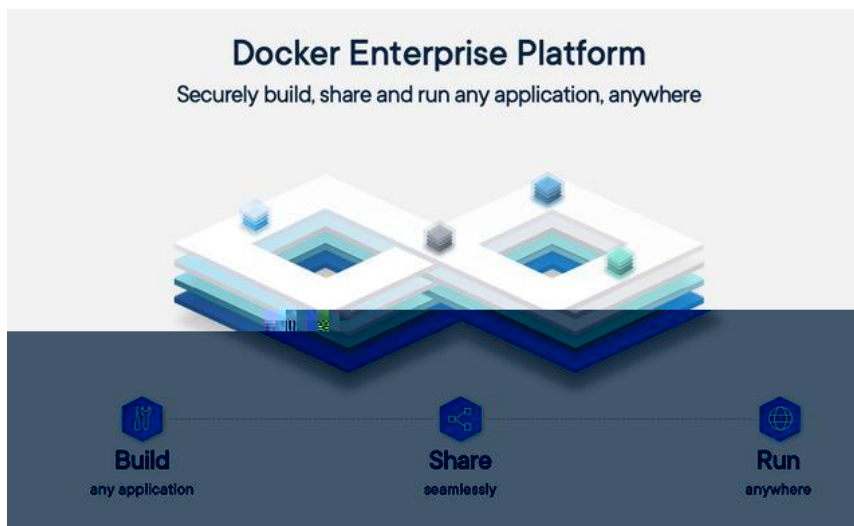

Docker      Docker Enterprise 3.0

Docker Enterprise



A

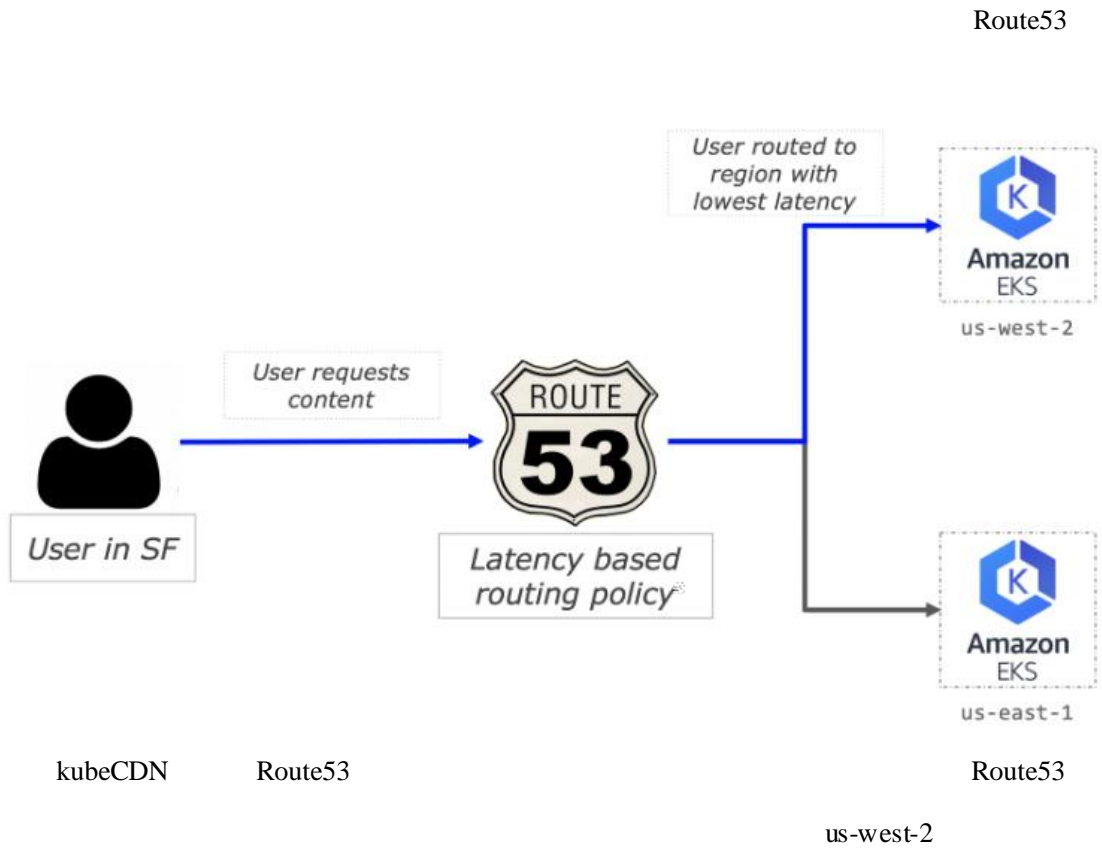

<https://docs.aws.amazon.com/Route53/latest/DeveloperGuide/routing-policy.html>

1. 2.0 12 1

2019 5 13

2.0

2.0 2019 12 1

1.0 2008

10

2.0

2.0

2019

1.0 2.0

2.0

2.0

1.0

2.0

1.0

2.0

1

2

3

4

5

2.0

## 2. Windows

## WannaCry

WannaCry

Windows

5 15

CVE-2019-0708

2017

WannaCry

POC

WannaCry

GitHub

Star

## 3.

## 2011

Meltdown

Spectre

Foreshadow

ZombieLoad

2011

PC

## 4. Windows 10 Oday

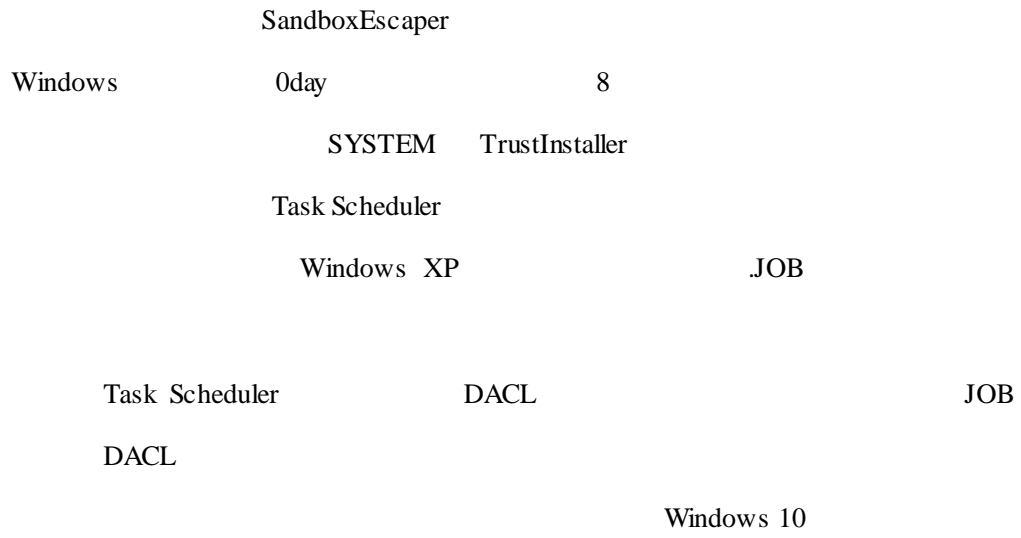

**1.**

**1.1 Elevate Security Phish5**

5 2 Elevate Security Phish5 Elevate Security  
2017 Phish5

**1.2 KnowBe4 CLTRe AS**

5 21 Know Be4 CLTRe CLTRe  
CLTRe Know Be4

**2.**

**2.1 HyperQube 50**

5 8 HyperQube Adam Ghetti 5 50  
HyperQube IT

**2.2 Siemplify 3000 C**

5 20 Siemplify 83North 3 3000 C  
Siemplify SOAR

**2.3 GuardiCore 6000 C**

5 20 GuardiCore 83North 7 6000 C  
Guardicore